

Slat16

Instrucciones de uso
Operating instructions
Bedienungsanleitung
Mode d'emploi
Istruzioni d'uso
Instruções de uso



Control de tensión.

1

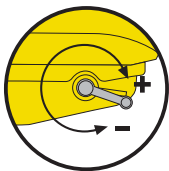
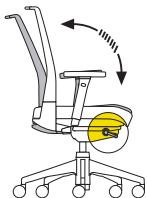

Bloqueo del respaldo.

2

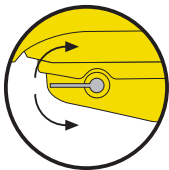
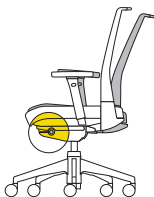

Altura lumbar.

3

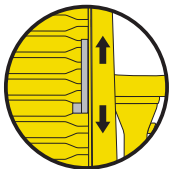
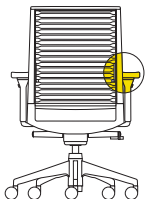

Altura asiento.

4

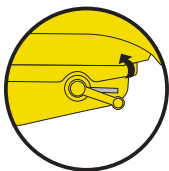
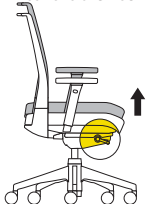

Profundidad del asiento.

5

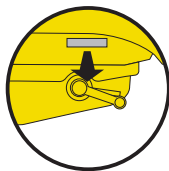
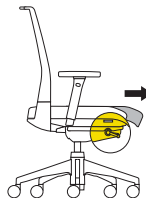

Altura de los brazos.

6

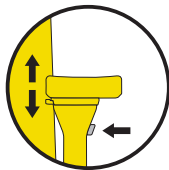
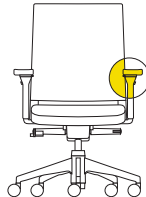

Apoyabrazos giratorio.

7

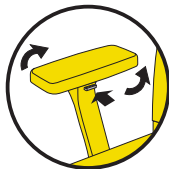
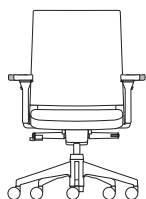

Profundidad del apoyabrazos.

8

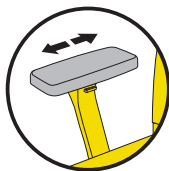

Cuidado y mantenimiento.

Plástico. Para una limpieza normal, lavar la superficie del plástico con un paño humedecido en agua templada con un detergente muy suave. Aclarar cuidadosamente y secar con un paño suave. No utilizar disolventes o limpiadores de cocina abrasivos.

Tapicería. Para una limpieza normal, aspirar la tapicería tanto como sea necesario utilizando un accesorio adecuado.

La mayoría de los tipos de manchas se pueden eliminar con agua tibia, añadiendo, si es necesario, un detergente neutro. Siempre utilice un paño limpio de algodón blanco. No se moje toda la pieza de mobiliario y utilizar sólo pequeñas cantidades de producto de limpieza a la vez.

No frotar demasiado vigorosamente o puede dañar los flecos o fibras. Es mejor varias aplicaciones suaves que una aplicación fuerte.

Piel. Para una limpieza normal, aspirar o quitar el polvo frecuentemente con un paño seco. Si la piel está sucia, se puede limpiar con un paño húmedo en agua tibia y un jabón suave. No limpie sólo la superficie manchada sino toda la superficie. Pasar un paño humedecido y posteriormente un paño limpio y seco.

Medio - Ambiente.

La silla puede ser desmontada rápidamente para su reciclaje con herramientas comunes. Es reciclable en un 92,87 % y todas sus piezas menores de 50 grs. están identificadas. Su peso aligerado (13,7 kgr) reduce el impacto de CO₂ a la atmósfera.

Normativa.

EN1335

Modelo de utilidad / Diseño comunitario.

DC 1898875



Pressure control.

1

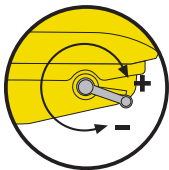
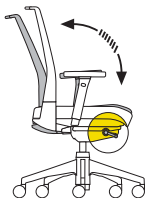

Seat depth.

5

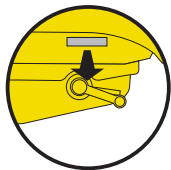
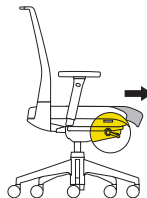

Backrest lock.

2

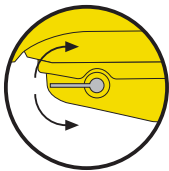
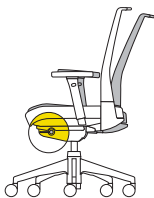

Arm height.

6

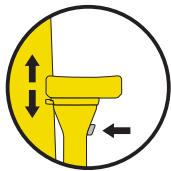
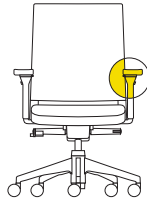

Lumbar support height.

3

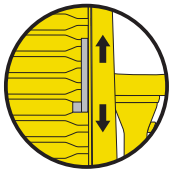
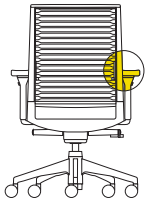

Rotating armrests.

7

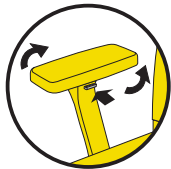
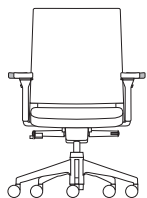

Seat height.

4

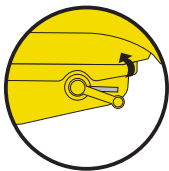
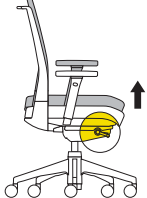

Armrest depth.

8

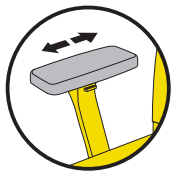

Care and maintenance.

Plastic. For normal cleaning, wash the plastic surface with a cloth moistened with warm water and a very mild detergent. Remove all the detergent carefully with a cloth moistened in clean water and dry with a soft cloth. Do not use solvents or abrasive kitchen cleaning products.

Upholstery. For normal cleaning, vacuum the upholstery as much as necessary using a suitable accessory.

Most stains can be removed with warm water and, if necessary, a neutral detergent. Always use a clean white cotton cloth. Do not soak the entire piece of furniture and only use small quantities of cleaning product at a time.

Do not rub too hard; you may damage the fringes or fibres. Several gentle cleans are better than one hard clean.

Leather. For normal cleaning, vacuum or remove dust frequently with a dry cloth. If the leather is dirty, it can be cleaned with a cloth moistened in lukewarm water and a mild soap. Do not clean just the stained area, but the entire surface. Wipe with a damp cloth and then a dry, clean one.

The Environment.

The chair can be dismantled quickly using common tools for recycling purposes. It is 91% recyclable and all parts of less than 50 g. are identified. Its light weight (13.7 kg) reduces the impact of CO₂ emissions into the atmosphere.

Standard.

EN1335

Utility model / Community design.

DC 1898875

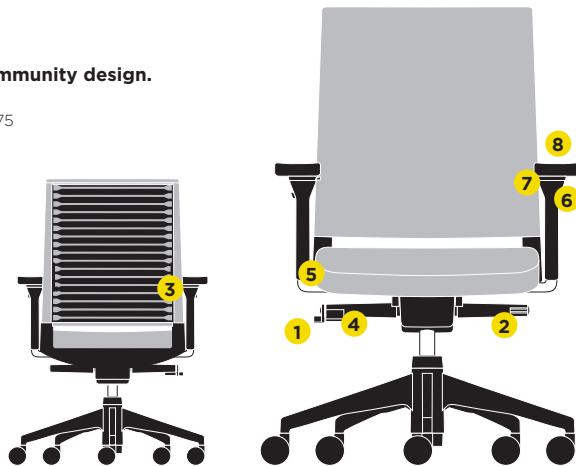

Spannungskontrolle.

1

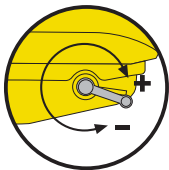
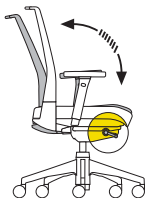

Rückenlehnenblockierung.

2

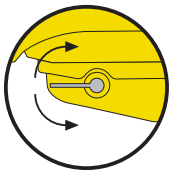
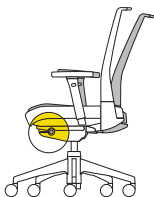

Lumbarstützenhöhe.

3

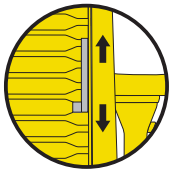
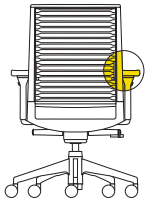

Sitzhöhe.

4

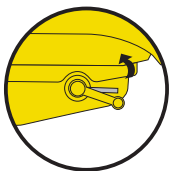
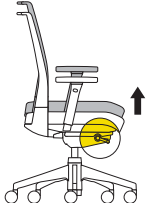

Sitztiefe.

5

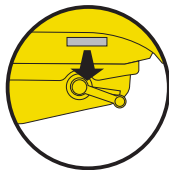
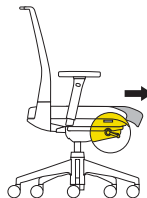

Armlehnenhöhe.

6

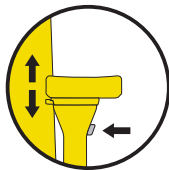
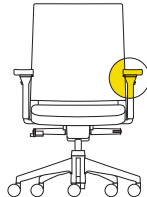

Drehbare Armlehnen.

7

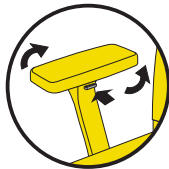
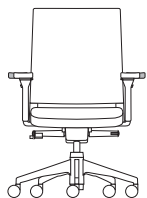

Armlehntiefe.

8

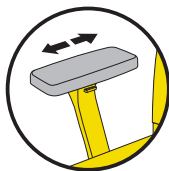

Pflege und Instandhaltung.

Kunststoff. Für die gewöhnliche Reinigung die Kunststoffoberfläche mit einem feuchten Tuch und einem sehr milden Reinigungsmittel abwaschen. Sorgfältig nachwischen und mit einem weichen Tuch trocknen. Keine Lösungs- oder Scheuermittel verwenden.

Polster. Für die gewöhnliche Reinigung die Polster mit einem entsprechenden Aufsatz absaugen.

Die meisten Flecken lassen sich mit lauwarmem Wasser entfernen. Falls erforderlich ein neutrales Reinigungsmittel verwenden. Immer ein sauberes weißes Baumwolltuch verwenden. Niemals das ganze Möbelstück nassmachen und jeweils nur eine geringe Menge Reinigungsmittel verwenden.

Nicht zu stark reiben. Dies könnte die Ränder oder Fasern beschädigen. Es ist besser, mehrere sanfte Reinigungsvorgänge durchzuführen als einen allzu gründlichen.

Leder. Für die gewöhnliche Reinigung den Staub regelmäßig mit einem trockenen Tuch entfernen. Wenn das Leder stärker verschmutzt ist, kann man es mit lauwarmen Seifenlauge und einem Lappen abwaschen. Reinigen Sie niemals nur die Flecken, sondern die gesamte Oberfläche. Zuerst mit einem feuchten Tuch reinigen, anschließend mit einem sauberen trockenen Tuch nachwischen.

Umwelt.

Der Stuhl lässt sich fürs Recycling mit normalem Werkzeug schnell auseinandermontieren. Er ist zu 91% recycelbar und alle Teile unter 50 gr sind gekennzeichnet. Sein geringes Gewicht (13,7 kg) reduziert die CO₂-Belastung der Atmosphäre.

Normen.

EN1335

Gebrauchsmuster / EU-Design.

DC 1898875

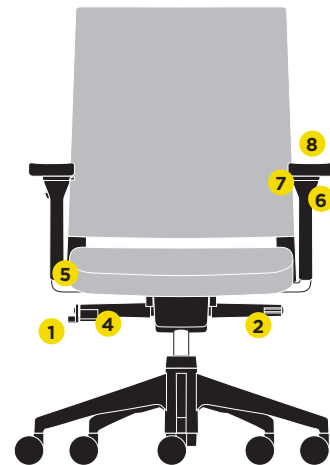

Contrôle de tension.

1

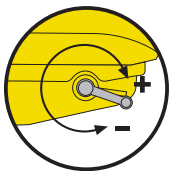
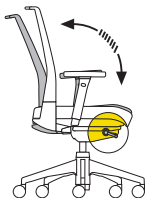

Blocage du dossier.

2

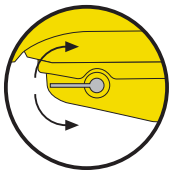
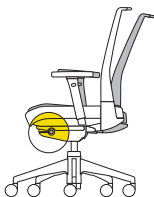

Hauteur lombaire.

3

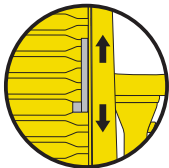
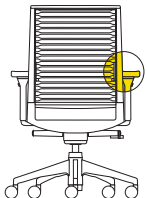

Hauteur assise.

4

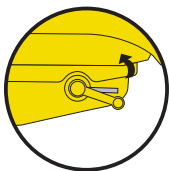
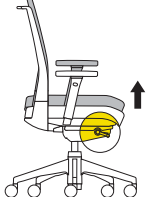

Profondeur de l'assise.

5

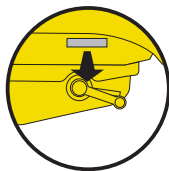
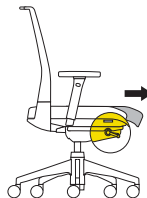

Hauteur des accoudoirs.

6

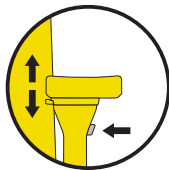
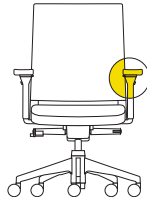

Accoudoir tournant.

7

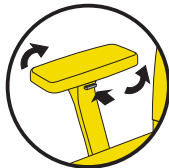
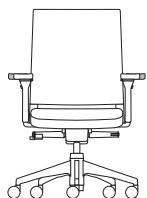

Profondeur de l'accoudoir.

8

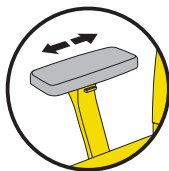

Soin et entretien.

Plastique. Pour un nettoyage normal, laver la surface en plastique avec un chiffon humidifié à l'eau tiède avec un détergent très doux. Rincer soigneusement et sécher avec un chiffon doux. Ne pas utiliser de produits solvants ou de nettoyants abrasifs.

Tapiserie. Pour un nettoyage normal, aspirer la tapiserie autant de fois que nécessaire, en utilisant un accessoire approprié.

La plupart des taches peuvent être éliminées à l'eau tiède, en ajoutant, si besoin, un détergent neutre. Toujours utiliser un chiffon propre en coton blanc. Ne jamais mouiller toute la pièce de mobilier et utiliser uniquement de petites quantités de produit de nettoyage à chaque fois.

Ne pas frotter trop vigoureusement ou vous pourriez endommager les franges ou fibres. Préférer plusieurs applications douces à une application forte.

Cuir. Pour un nettoyage normal, aspirer ou enlever la poussière fréquemment avec un chiffon sec. Si le cuir est sale, le nettoyer avec un chiffon imbibé d'eau tiède avec un savon doux. Ne pas nettoyer seulement la surface tachée, mais toute la surface. Passer un chiffon humide, puis un chiffon propre et sec.

Environnement.

Le siège peut être démonté rapidement pour son recyclage avec des outils communs. Il est recyclable à 91 % et toutes ses pièces de moins de 50 g sont identifiées. Son poids allégé (13,7 kg) réduit l'impact de CO₂ dans l'atmosphère.

Réglementation.

EN1335

Modèle d'utilité / Conception communautaire.

DC 1898875

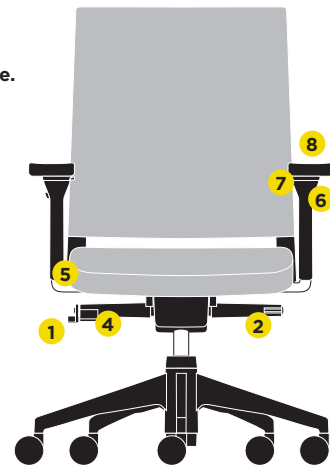

Controllo di tensione.

1

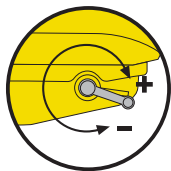
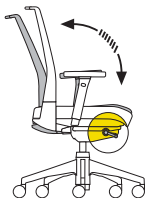

Blocco dello schienale.

2

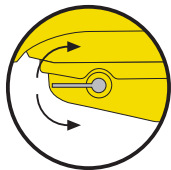
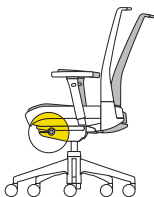

Altezza lombare.

3

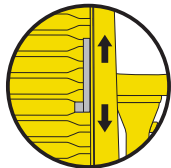
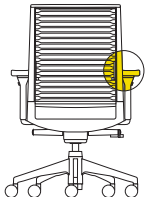

Altezza sedile.

4

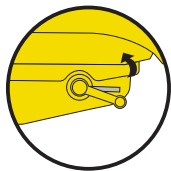
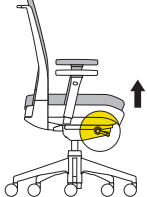

Profondità sedile.

5

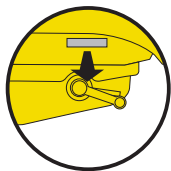
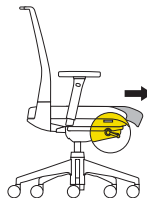

Altezza dei braccioli.

6

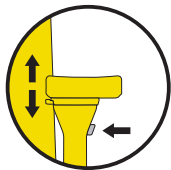
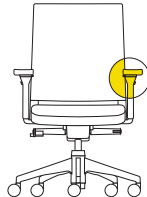

Braccioli girevoli.

7

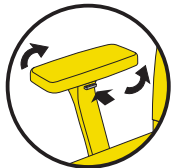
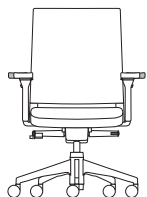

Profondità dei braccioli.

8

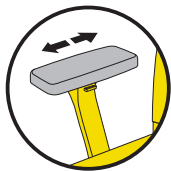

Cura e manutenzione.

Plastica. Per una pulizia normale, lavare la superficie della plastica con un panno inumidito in acqua tiepida con un detersivo molto delicato. Sciacquare attentamente e asciugare con un panno morbido. Non usare solventi o prodotti di pulizia abrasivi da cucina.

Rivestimento. Per una pulizia normale, aspirare il tessuto per il tempo necessario utilizzando un accessorio adeguato.

La maggior parte dei tipi di macchie si può eliminare con acqua tiepida, aggiungendo, se necessario, un detersivo neutro. Usare sempre un panno pulito di cotone bianco. Non bagnare tutto il mobile e usare solo piccole quantità di detersivo alla volta.

Non strofinare troppo vigorosamente per non danneggiare le frange o le fibre. Varie applicazioni delicate sono preferibili a un'applicazione forte.

Pelle. Per una pulizia normale, aspirare o spolverare frequentemente con un panno asciutto. Se la pelle è sporca, si può pulire con un panno umido in acqua tiepida e un sapone delicato. Non pulire solo la parte macchiata, ma tutta la superficie. Passare un panno inumidito e, in seguito, un panno asciutto e pulito.

Ambiente.

La sedia può essere smontata velocemente e con attrezzi comuni per il suo riciclaggio. È riciclabile al 91% e tutti i pezzi di meno di 50 gr sono identificati. Il suo peso ridotto (13,7 kg) riduce l'impatto di CO₂ nell'atmosfera.

Normativa.

EN1335

Modello di utilità / Designo comunitario.

DC 1898875

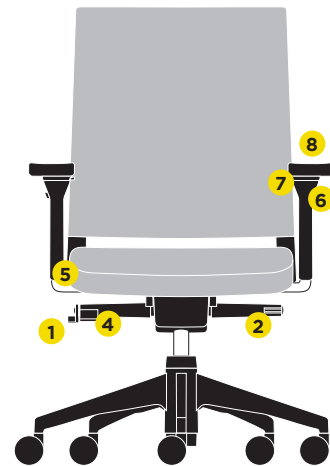

Controle de tensão.

1

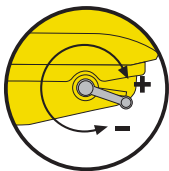
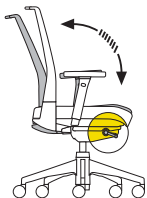

Travamento do Encosto.

2

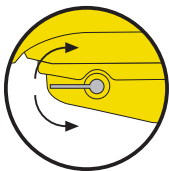
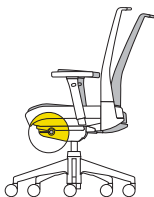

Altura da lombar.

3

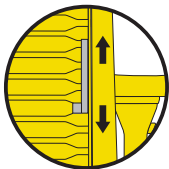
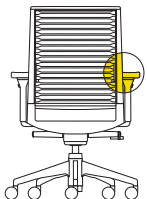

Altura do assento.

4

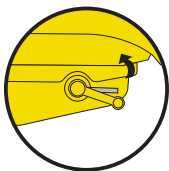
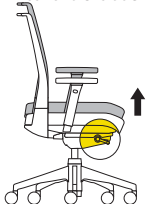

Profundidade do assento.

5

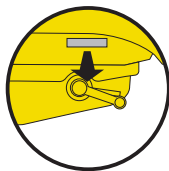
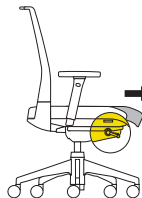

Altura do apoio de braços.

6

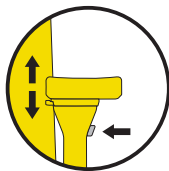
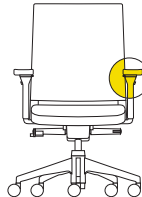

Apoio de braço giratório.

7

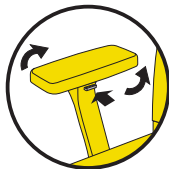

Profundidade do apoio de braços.

8

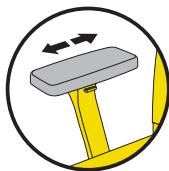

Cuidados e manutenção.

Plásticos. Para uma limpeza normal, utilizar pano úmido em água morna ou temperatura ambiente e detergente neutro. Enxaguar cuidadosamente e secar com pano macio. Não utilizar solventes ou produtos limpadores de cozinha abrasivos.

Estofamento. Para uma limpeza normal, aspirar as partes com tecidos utilizando um acessório adequado no aspirador.

A maioria dos tipos de manchas pode ser eliminada com água morna, acrescentando, se necessário, detergente neutro. Sempre utilize um pano macio, limpo de algodão. Não molhar toda a peça e utilizar pequenas quantidades de produto de limpeza a cada vez.

Não esfregar rigorosamente, caso contrário, danificará o tecido e seus componentes. Repetir várias aplicações suavemente é preferível que uma única com vigor.

Couro. Para uma limpeza normal, aspirar, com o acessório adequado, ou tirar o pó frequentemente com um pano seco. Caso esteja muito sujo, pode-se utilizar um pano macio umedecido em água morna e sabão neutro. Neste caso não limpe somente a área suja e sim a totalidade da superfície do couro. Após essa limpeza passar um pano limpo e seco.

Meio Ambiente.

A cadeira é desmontada fácil e rapidamente, para reciclagem das peças, com ferramentas comuns. É reciclável 92,87% e todas as peças desmontadas que pesam menos de 50 g, estão identificadas. Seu baixo peso (13,7 kg) reduz o impacto de CO₂ na atmosfera.

Norma.

EN1335

Modelo de utilidade / Desenho comunitário.

DC 1898875



Respaldo 52.
Backrest 52.
Rückenlehne 52.
Dossier 52.
Schienale 52.
Encosto 52.

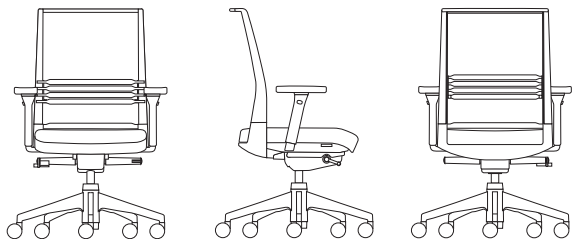

Malla.
Mesh.
Netzgewebe.
Réssille.
Rete.
Malha.

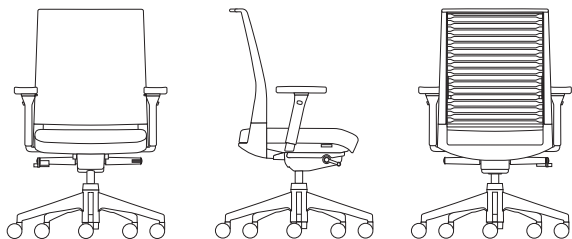

Tapizada.
Upholstered.
Gepolstert.
Tapissé
Rivestita
Estofados.

dynamobel



Dynamobel S.A.

Ctra. Madrid km.24

31350 Peralta

Navarra Spain

T +34 948 750 000

F +34 948 750 750

info@dynamobel.com

www.dynamobel.com